



# Technical Data

Specification & Capacities

# SPX532

## OVERALL DIMENSIONS

### SPX532CDH JIB STOWED

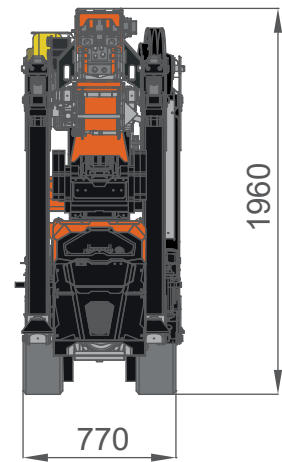
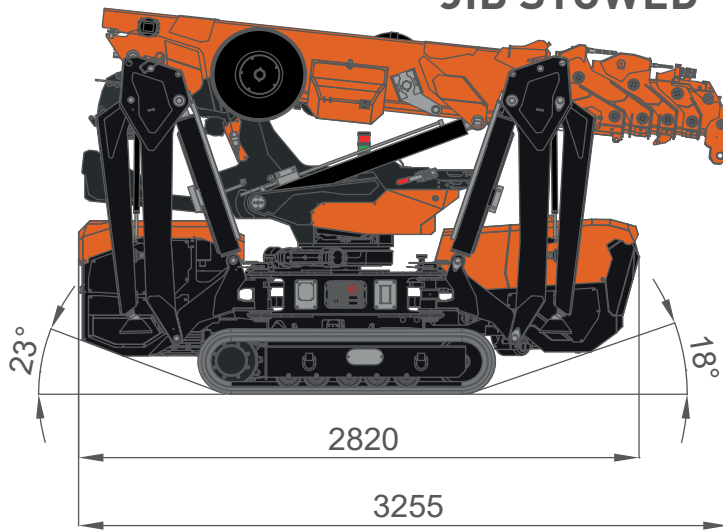

### JIB MOUNTED

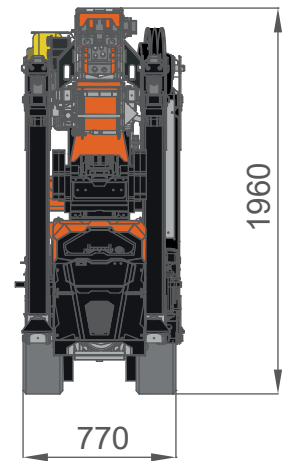
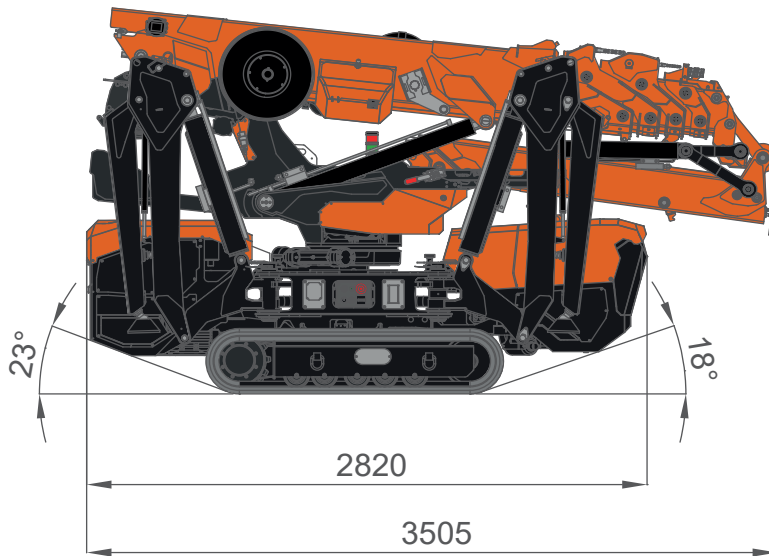

### EXTENDED TRACKS

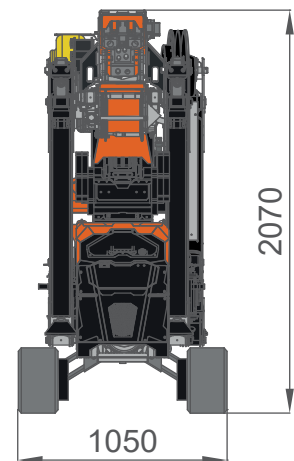
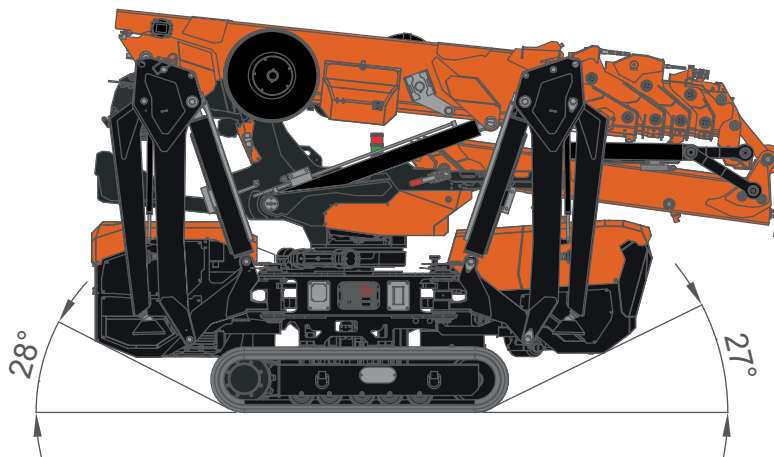

[mm]



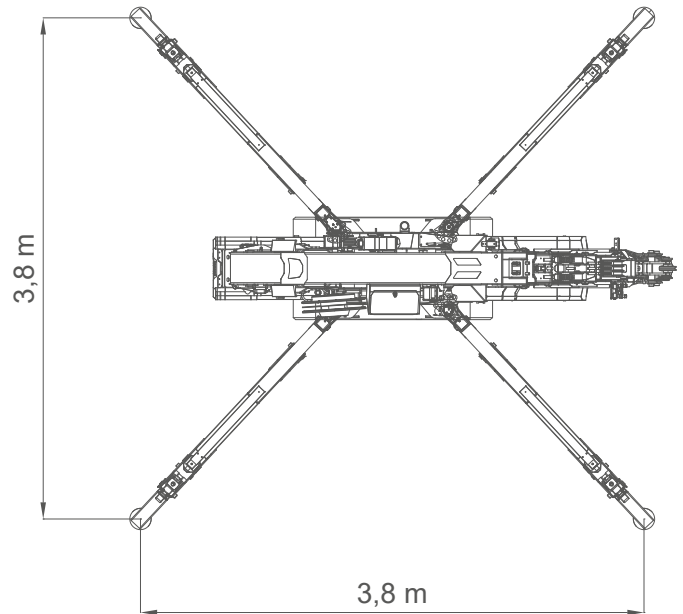
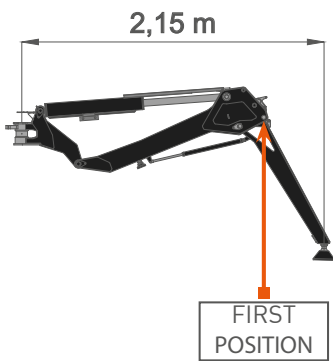

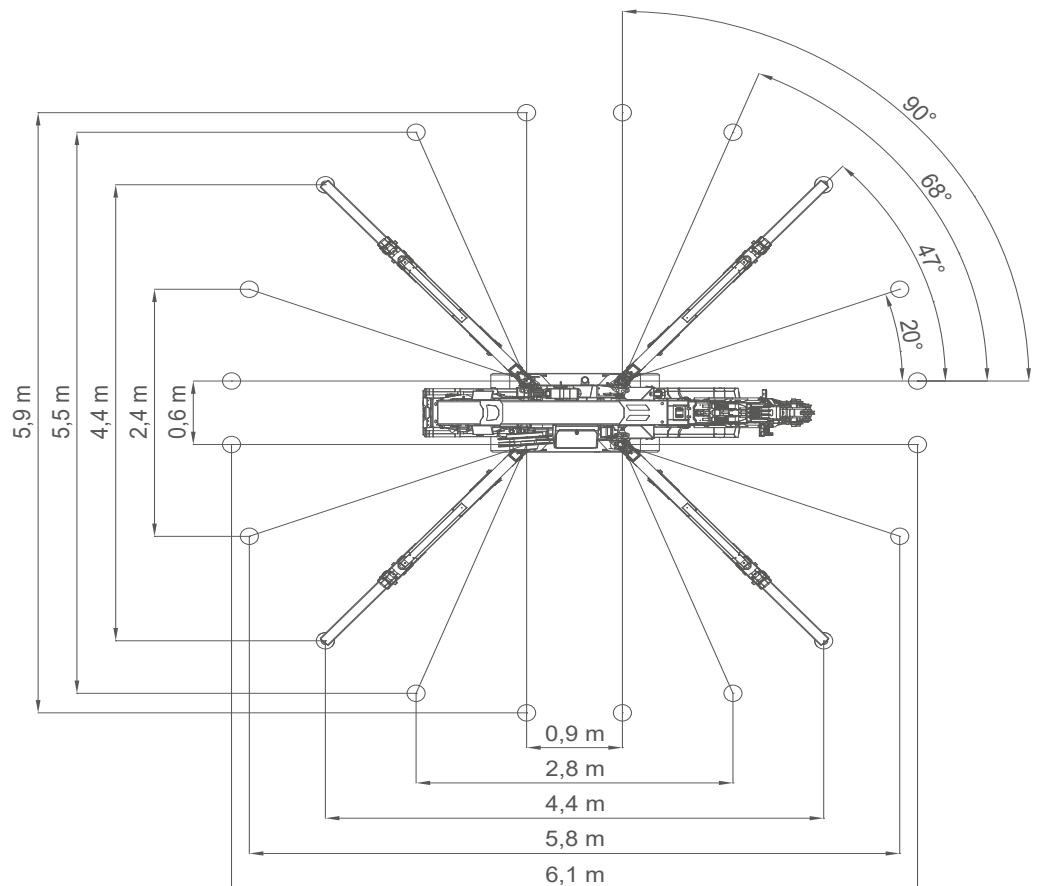
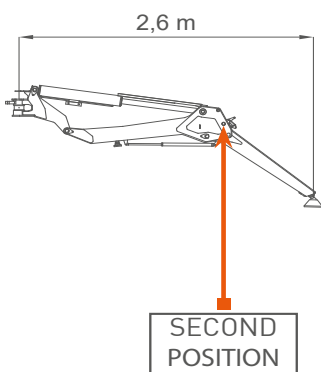

## OVERALL DIMENSIONS SQUARE OUTRIGGER 1<sup>ST</sup> POSITION STABILITY















## OUTRIGGER 2<sup>ND</sup> POSITION FULL STABILITY



## OVERALL INFORMATION

		Name/ version	kg*
WEIGHTS	 Crane	CDH, CL, CL2	2520
	 Winch	W800.6	52
	 Hookblock	SINGLE FALL	20
		MULTIPLE FALL	49
	 Power Pack	1-PHASE POWERPACK	52
		3-PHASE POWERPACK	63
	 Jib	JIB1200GX	50
		JIB1000.2H1MX	210
		MANUAL EXTENSION	14
		PULLEY HEAD	8
 Grabber	JIB500GR	217	
 Outriggers mats	OM400	17	

ENGINE	 Engine	KUBOTA D902-E4B		
	<b>kW</b> Power	16,1kW 22HP		
	 Fuel	DIESEL		
ELECTRIC	 Tank	L	10	
	 Lithium Battery	CL: 24V 300Ah		
	<b>kW</b> Power	24V-3F 5,5kW 7,5HP		
	 Lithium Battery	CL2: 48V 200Ah		
HYDRAULIC	 Hydraulic Oil	ISO 6743-4:HFDU with VG46 viscosity class		
		Working temp	<70°C	
	MOVEMENTS	 Travel Speed	km/h	CDH: 2,7 CL, CL2 : 1,8
			 Gradeability	20° [36%] <sup>†</sup>
		 Track Load	kg/cm <sup>2</sup>	0,63
 Outrigger Load	kg	3000 <sup>‡</sup>		
MOVEMENTS	 Working Angle	0°/80°		
		s	30	
	 Slewing	360°		
		rpm	0,85	
 Boom Telescoping	m	2,5 - 10,8		
	s	40		

\*: Dry weight  
†: Engine working limit  
‡: Static lifting

## HOIST PERFORMANCE

<b>GEAR WINCH</b>	<b>Layer</b>	<b>Max line pull</b>	<b>Standard rope speed</b>	<b>Highest rope speed</b>
		kg	m/min	m/min
	1	785		25
	2	730		27
	3	680		29
	4	640		31
	5	600		33
<b>ROPE</b>	<b>Wire rope</b>	<b>∅</b>	<b>Total length</b>	<b>Max load</b>
		mm	m	kg
	19x7 right lang lay Non rotating	7	81	4700
<b>PISTON WINCH</b>	<b>Layer</b>	<b>Max line pull</b>	<b>Standard rope speed</b>	<b>Highest rope speed</b>
		kg	m/min	m/min
	1	980*		16
	2	910*		17
	3	860*		19
	4	810*		20
<b>ROPE</b>	<b>Wire rope</b>	<b>∅</b>	<b>Total length</b>	<b>Max load</b>
		mm	m	kg
	19x7 right lang lay Non rotating	7	68	4700
<b>HOOK BLOCK</b>	<b>Load</b>	<b>N° of</b>		<b>Block type</b>
	kg	Sheaves	Lines	
	3200	2	4	Multiple fall block
	2400	1	3	
	1600	1	2	
800	-	1	Single fall block	

\*: LMI limited at 800 kg

**PULLEY HEAD AND HOOKBLOCK**

**TILTING PULLEY HEAD**

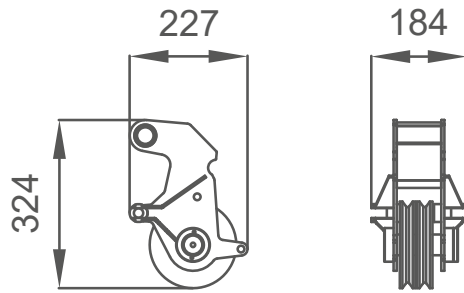

**SINGLE FALL**

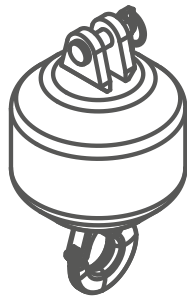

**MULTIPLE FALLS**

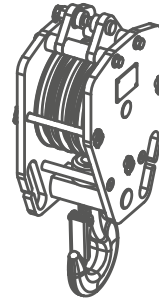

## CRANE PERFORMANCE

		d			
		1,1 m	1,8 m	2,2m	
<b>CRANE PERFORMANCE</b>	J7				
	J6				
	J5				
	J4				
	J3				
	J2				
	J1	PICK & CARRY			
	J0	No LIFTING CAPACITY			
			2,2 x 2,2 m	3,6 x 3,6 m	4,4 x 4,4 m
	<b>STABILITY AREA</b>				

### STABILITY EXAMPLES

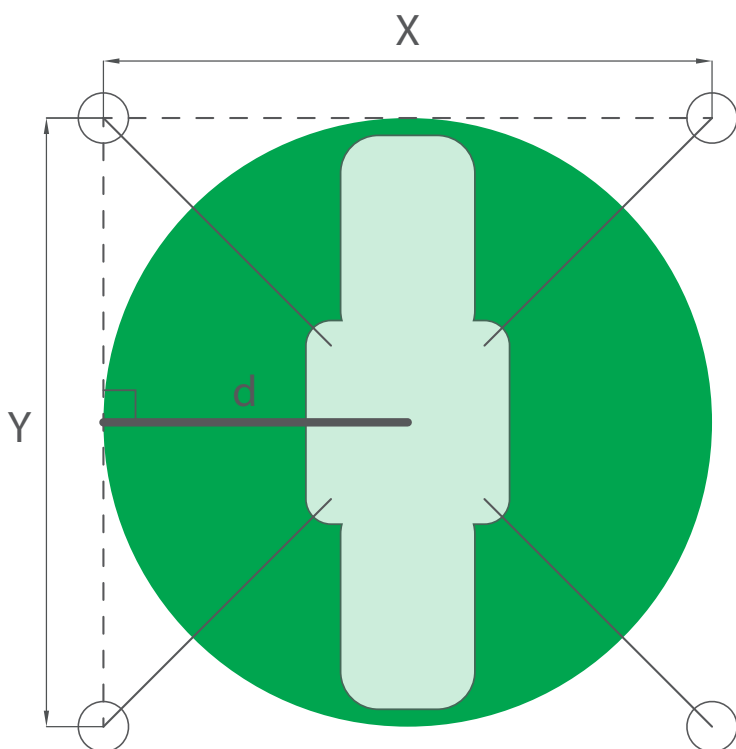

Example 1:  
Square stability area.

$X = 4,4 \text{ m}$   
 $Y = 4,4 \text{ m}$   
 $d = 2,2 \text{ m}$

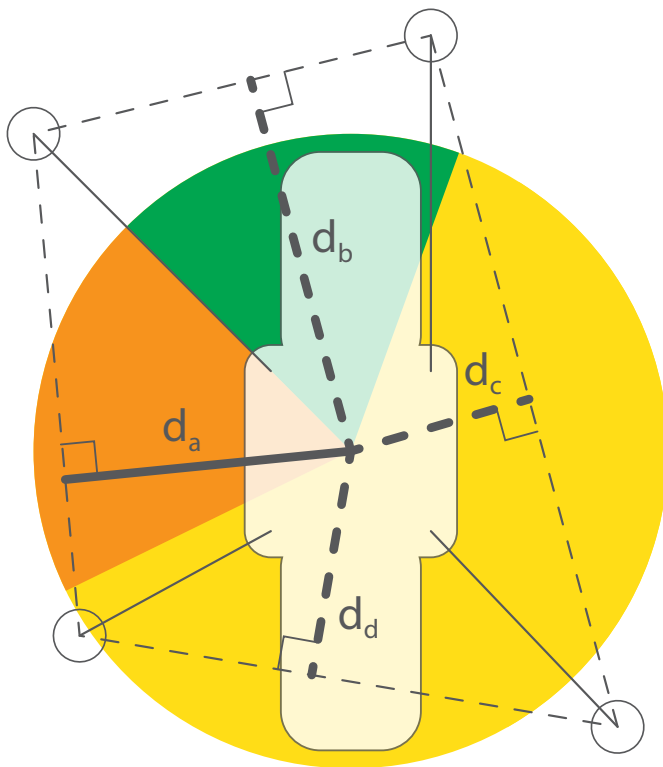

Example 2:  
Asymmetric stability area.

$d_a = 1,9 \text{ m}$   
 $d_b = 2,2 \text{ m}$   
 $d_c = 1,3 \text{ m}$   
 $d_d = 1,3 \text{ m}$

Example 3:  
Close outriggers stability area.

$X = 0,6 \text{ m}$   
 $Y = 5,0 \text{ m}$   
 $d_a = 0,3 \text{ m}$   
 $d_b = 2,5 \text{ m}$   
 $d_c = 0,3 \text{ m}$   
 $d_d = 2,5 \text{ m}$

$d_b$  and  $d_d$  should be J7 geometrically but is limited to J0 anyway because too narrow.

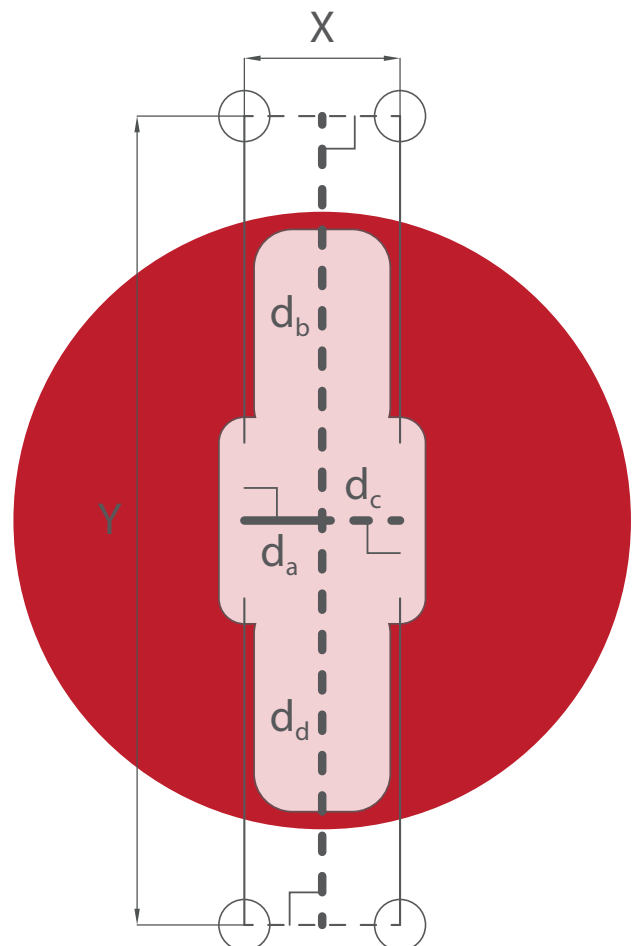



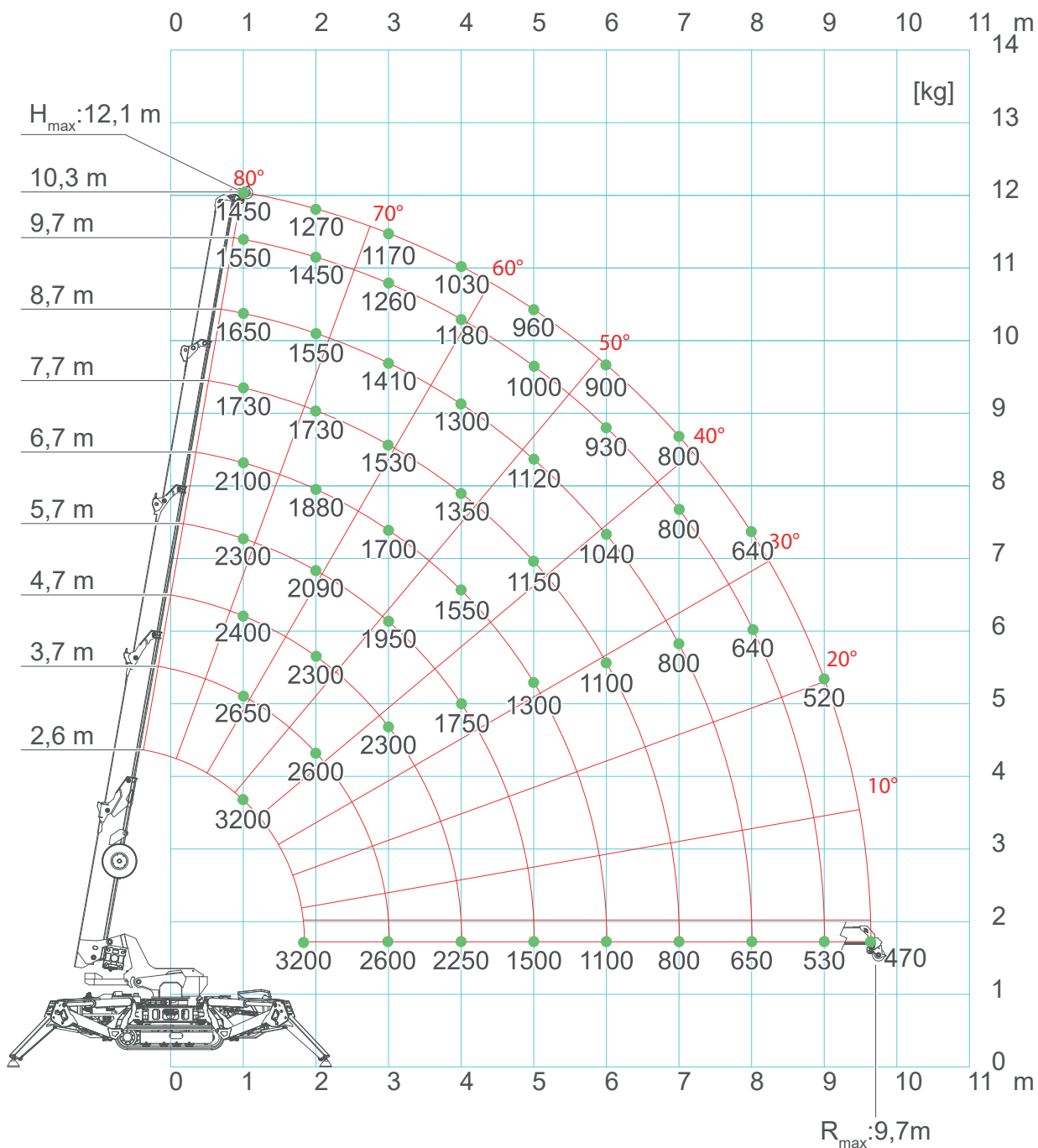

## SPX532 - MAIN BOOM



## SPX532 - MAIN BOOM

 CRANE PERFORMANCE: J7										
[m] L →	2,6	2,7	3,7	4,7	5,7	6,7	7,7	8,7	9,7	10,3
1	3,20	3,00	2,65	2,40	2,30	2,10	1,73	1,65	1,55	1,45
2	3,20	3,20	2,60	2,30	2,09	1,88	1,73	1,55	1,45	1,27
3			2,60	2,30	1,95	1,70	1,53	1,41	1,26	1,17
4				2,25	1,75	1,55	1,35	1,30	1,18	1,03
5					1,50	1,30	1,15	1,12	1,00	0,96
6						1,10	1,10	1,04	0,93	0,90
7							0,80	0,80	0,80	0,80
8								0,65	0,64	0,64
9									0,53	0,52
9,45*										0,47
↑R [m]	[ton]									

LC532\_V202\_0521\_BP\_GANCIO\_J7

 CRANE PERFORMANCE: J6										
[m] L →	2,6	2,7	3,7	4,7	5,7	6,7	7,7	8,7	9,7	10,3
1	3,20	3,00	2,65	2,40	2,30	2,10	1,73	1,65	1,55	1,45
2	3,20	3,20	2,60	2,30	2,09	1,88	1,73	1,55	1,45	1,27
3			2,60	2,30	1,95	1,70	1,53	1,41	1,26	1,17
4				1,70	1,65	1,50	1,35	1,30	1,18	1,03
5					1,10	1,10	1,10	1,00	1,00	0,96
6						0,80	0,80	0,80	0,80	0,80
7							0,60	0,60	0,60	0,60
8								0,48	0,48	0,48
9									0,40	0,40
9,45*										0,32
↑R [m]	[ton]									

LC532\_V202\_0521\_BP\_GANCIO\_J6

## SPX532 - MAIN BOOM

[m] L →	2,6	2,7	3,7	4,7	5,7	<b>CRANE PERFORMANCE: J5</b>
1	1,50	1,50	1,00	0,70	0,40	
2	1,20	1,20	0,70	0,50	0,40	
3			0,60	0,45	0,30	
4				0,35	0,28	
5					0,20	
↑R [m]	[ton]					LC532_V202_0521_BP_GANCIO_J5

[m] L →	2,6	2,7	<b>CRANE PERFORMANCE: J1</b>
1	0,40	0,40	
2		0,11	
↑R [m]	[ton]		

LC532\_V202\_0521\_BP\_GANCIO\_J1

\*: Refers to hook configuration. Pulley configuration is 0,1m longer.

## SPX532 - JIB1000.2H1MX

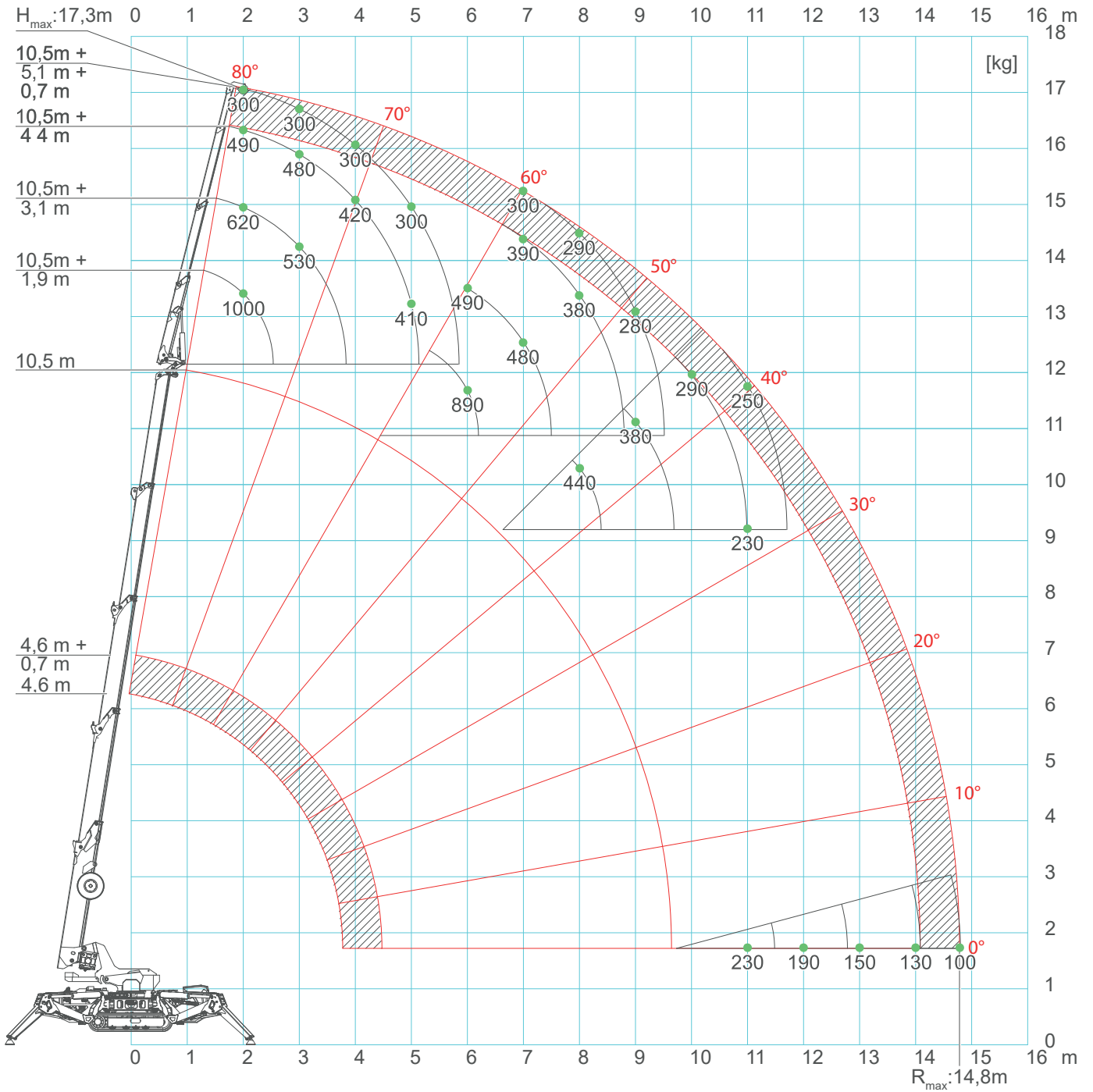

\*: Refers to hook configuration. Pulley configuration is 0,1m longer.

## SPX532 - JIB1000.2H1MX

<b>CRANE PERFORMANCE: J7</b>				
[m] L <sub>J</sub> →	1,9	3,1	4,4	5,1
1	1,00	0,70	0,50	0,46
2	1,00	0,62	0,49	0,40
3	1,00	0,53	0,48	0,35
4	1,00	0,51	0,42	0,33
5	1,00	0,50	0,41	0,32
6	0,89	0,49	0,40	0,31
7	0,67	0,48	0,39	0,30
8	0,44	0,40	0,38	0,29
9	0,38	0,38	0,34	0,28
10	0,29	0,29	0,29	0,25
11		0,23	0,23	0,23
12		0,19	0,19	0,19
13			0,15	0,15
14			0,14	0,13
14,8				0,10
↑R [m]	[ton]			

LC532\_V202\_0521\_JIB1000\_GANCIO\_J7

<b>CRANE PERFORMANCE: J6</b>				
[m] L <sub>J</sub> →	1,9	3,1	4,4	5,1
1	1,00	0,70	0,50	0,46
2	1,00	0,54	0,45	0,40
3	1,00	0,50	0,43	0,35
4	1,00	0,48	0,36	0,30
5	0,80	0,43	0,33	0,29
6	0,59	0,40	0,30	0,28
7	0,42	0,38	0,29	0,27
8	0,30	0,30	0,28	0,26
9	0,20	0,20	0,20	0,20
10	0,14	0,14	0,14	0,14
11	0,11	0,11	0,11	0,11
↑R [m]	[ton]			

LC532\_V202\_0521\_JIB1000\_GANCIO\_J6

## SPX532 - JIB1000.2H1MX

		CRANE PERFORMANCE: <b>J5</b>			
[m] L <sub>j</sub> →	1,9	3,1	4,4	5,1	
1	1,00	0,53	0,27	0,22	
2	0,80	0,42	0,25	0,21	
3	0,70	0,40	0,24	0,20	
4	0,40	0,30	0,23	0,19	
5	0,28	0,24	0,22	0,18	
↑R [m]	[ton]	LC532_V202_0521_JIB1000_GANCIO_J5			

		CRANE PERFORMANCE: <b>J1</b>	
[m] L <sub>j</sub> →	1,9		
1	0,12		
2	0,10		
3	0,10		
4	0,05		
↑R [m]	[ton]	LC532_V202_0521_JIB1000_GANCIO_J1	

\*: With manual extension on maximum weight is limited to 300kg.

## SPX532 - JIB1200GX

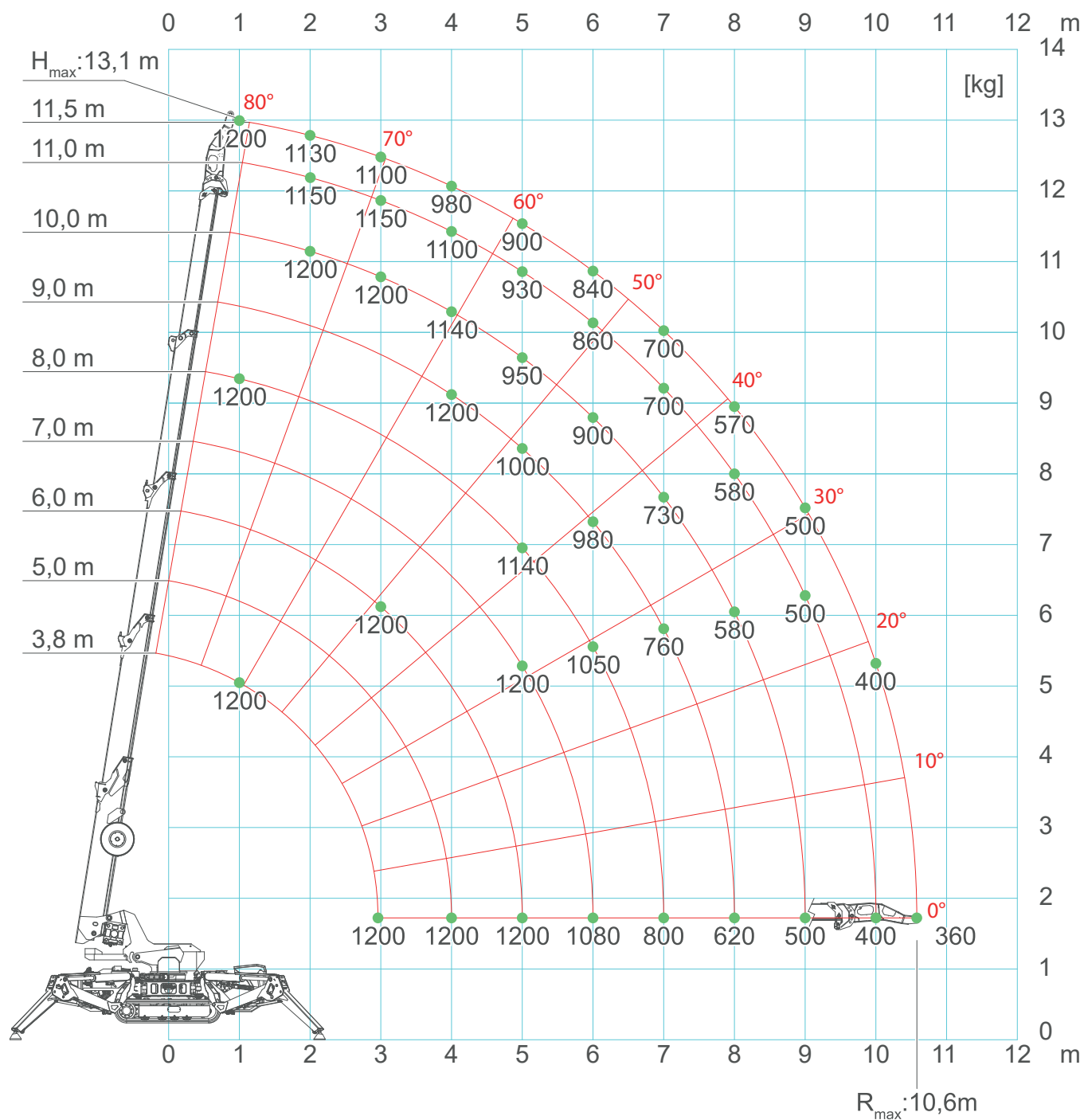

\*: With manual extension on maximum weight is limited to 300kg.

## SPX532 - JIB1200GX

		<b>CRANE PERFORMANCE: J7</b>									
[m] L →	2,6	2,7	3,7	4,7	5,7	6,7	7,7	8,7	9,7	10,3	
L+L <sub>J</sub> →	3,7	3,8	4,8	5,8	6,8	7,8	8,8	9,8	10,8	11,4	
1	1,25	1,25	1,25	1,25	1,25	1,25	1,25	1,25	1,25	1,25	
2	1,25	1,25	1,25	1,25	1,25	1,25	1,25	1,25	1,15	1,13	
3	1,25	1,25	1,25	1,25	1,25	1,25	1,25	1,25	1,15	1,10	
4			1,25	1,25	1,25	1,25	1,25	1,14	1,10	0,98	
5				1,25	1,25	1,14	1,00	0,95	0,93	0,90	
6					1,04	1,00	0,98	0,90	0,86	0,84	
7						0,78	0,76	0,73	0,70	0,70	
8							0,61	0,58	0,58	0,57	
9								0,49	0,49	0,49	
10									0,40	0,40	
10,5										0,35	
↑R [m]	[ton]										

LC532\_V202\_0521\_JIB1200GX\_GANCIO\_J7

		<b>CRANE PERFORMANCE: J6</b>									
[m] L →	2,6	2,7	3,7	4,7	5,7	6,7	7,7	8,7	9,7	10,3	
L+L <sub>J</sub> →	3,7	3,8	4,8	5,8	6,8	7,8	8,8	9,8	10,8	11,40	
1	1,25	1,25	1,25	1,25	1,25	1,25	1,25	1,25	1,25	1,25	
2	1,25	1,25	1,25	1,25	1,25	1,25	1,25	1,25	1,15	1,13	
3	1,25	1,25	1,25	1,25	1,25	1,25	1,25	1,25	1,15	1,00	
4			1,25	1,25	1,25	1,25	1,25	1,14	1,10	0,98	
5				1,08	1,00	0,96	0,95	0,93	0,92	0,90	
6					0,78	0,75	0,71	0,68	0,62	0,60	
7						0,58	0,56	0,54	0,50	0,48	
8							0,44	0,43	0,42	0,40	
9								0,35	0,35	0,32	
10									0,29	0,28	
10,5										0,25	
↑R [m]	[ton]										

LC532\_V202\_0521\_JIB1200GX\_GANCIO\_J6

\*: With manual extension on maximum weight is limited to 300kg.



## SPX532 - JIB1200GX

		<b>CRANE PERFORMANCE: J5</b>			
[m] L →	2,6	2,7	3,7	4,7	
L+L <sub>J</sub> →	3,7	3,8	4,8	5,8	
1	1,20	1,00	0,70	0,40	
2	1,11	0,60	0,50	0,36	
3	0,54	0,54	0,40	0,26	
4			0,28	0,22	
5				0,15	
↑R [m]	[ton]				

LC532\_V202\_0521\_JIB1200GX\_GANCIO\_J5

## SPX532 - JIB500GR

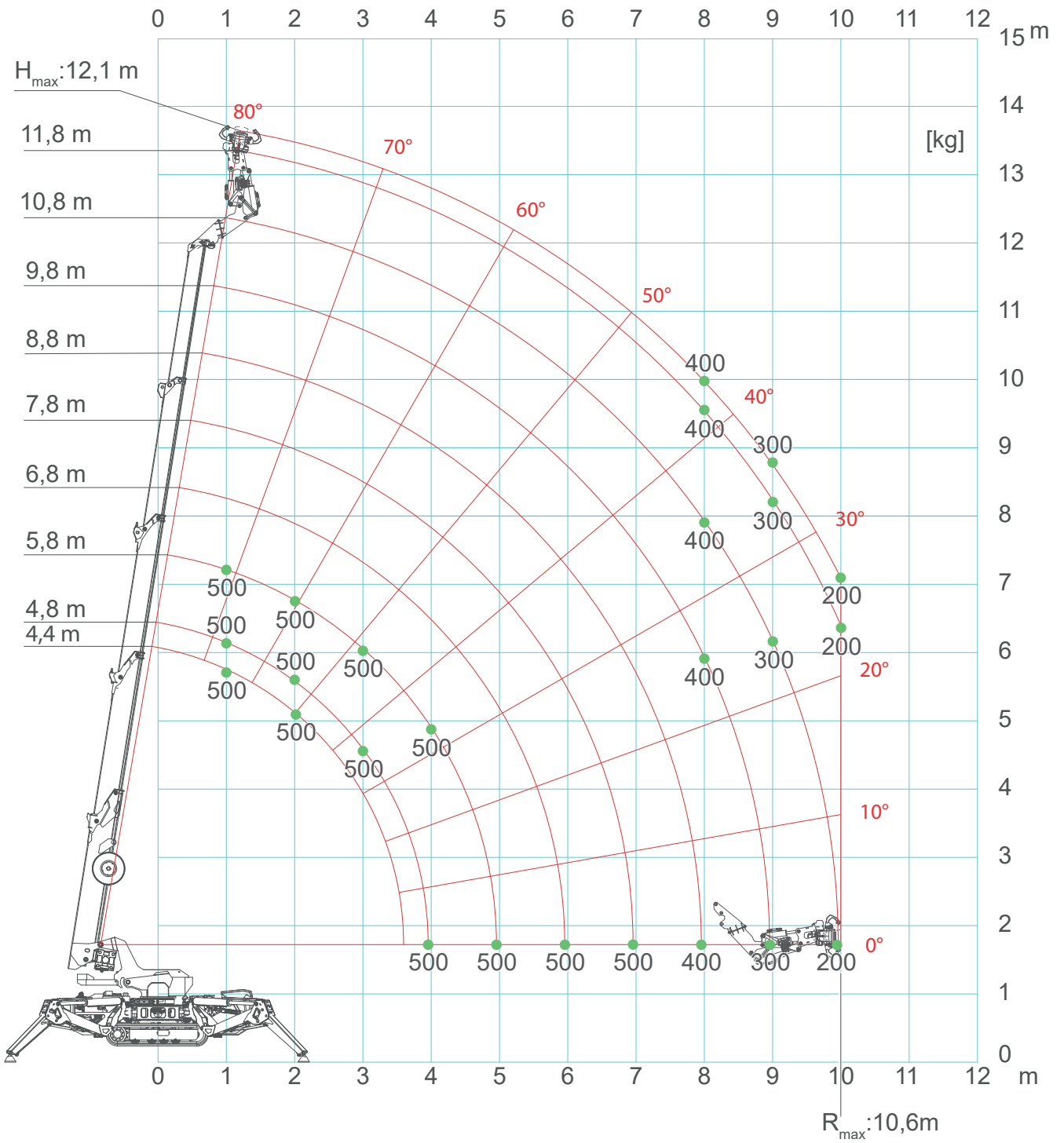

## SPX532 - JIB500GR

		<b>CRANE PERFORMANCE: J7</b>									
[m] L →	2,6	3,0	4,0	5,0	6,0	7,0	8,0	9,0	10,0	10,3	
L+L <sub>J</sub> →	4,4	4,7	5,7	6,7	7,7	8,7	9,7	10,7	11,7	12,0	
1	0,55	0,55	0,55	0,55	0,55	0,55	0,55	0,55	0,55	0,55	
4	0,55	0,55	0,55	0,55	0,55	0,55	0,55	0,55	0,55	0,55	
5			0,55	0,55	0,55	0,55	0,55	0,55	0,55	0,55	
6				0,55	0,55	0,55	0,55	0,55	0,55	0,55	
7					0,55	0,55	0,55	0,55	0,55	0,55	
8						0,40	0,40	0,39	0,39	0,39	
9							0,29	0,28	0,28	0,28	
10								0,20	0,20	0,20	
↑R [m]	[ton]										

LC532\_V202\_0521\_JIB1200GX\_GANCIO\_J7

		<b>CRANE PERFORMANCE: J6</b>									
[m] L →	2,6	3,0	4,0	5,0	6,0	7,0	8,0	9,0	10,0	10,3	
L+L <sub>J</sub> →	4,4	4,7	5,7	6,7	7,7	8,7	9,7	10,7	11,7	12,0	
1	0,55	0,55	0,55	0,55	0,55	0,55	0,55	0,55	0,55	0,55	
4	0,55	0,55	0,55	0,55	0,55	0,55	0,55	0,55	0,55	0,55	
5			0,55	0,55	0,55	0,55	0,55	0,55	0,55	0,55	
6				0,52	0,51	0,49	0,46	0,44	0,43	0,43	
7					0,35	0,34	0,33	0,31	0,31	0,31	
8						0,23	0,22	0,21	0,21	0,21	
8,1											
↑R [m]	[ton]										

LC532\_V202\_0521\_JIB1200GX\_GANCIO\_J6

## SPX532 - JIB1200GX

		CRANE PERFORMANCE: J5		
		[m]	[m]	[m]
[m] L →		2,6	3,0	4,0
L+L <sub>J</sub> →		3,7	4,1	5,1
1	0,55	0,55	0,55	
2	0,55	0,55	0,55	
3	0,55	0,40	0,40	
4		0,30	0,30	
5			0,20	
↑R [m]	[ton]			

LC532\_V202\_0521\_JIB1200GX\_GANCIO\_J5



## ACCESSORIES SPX532CDH

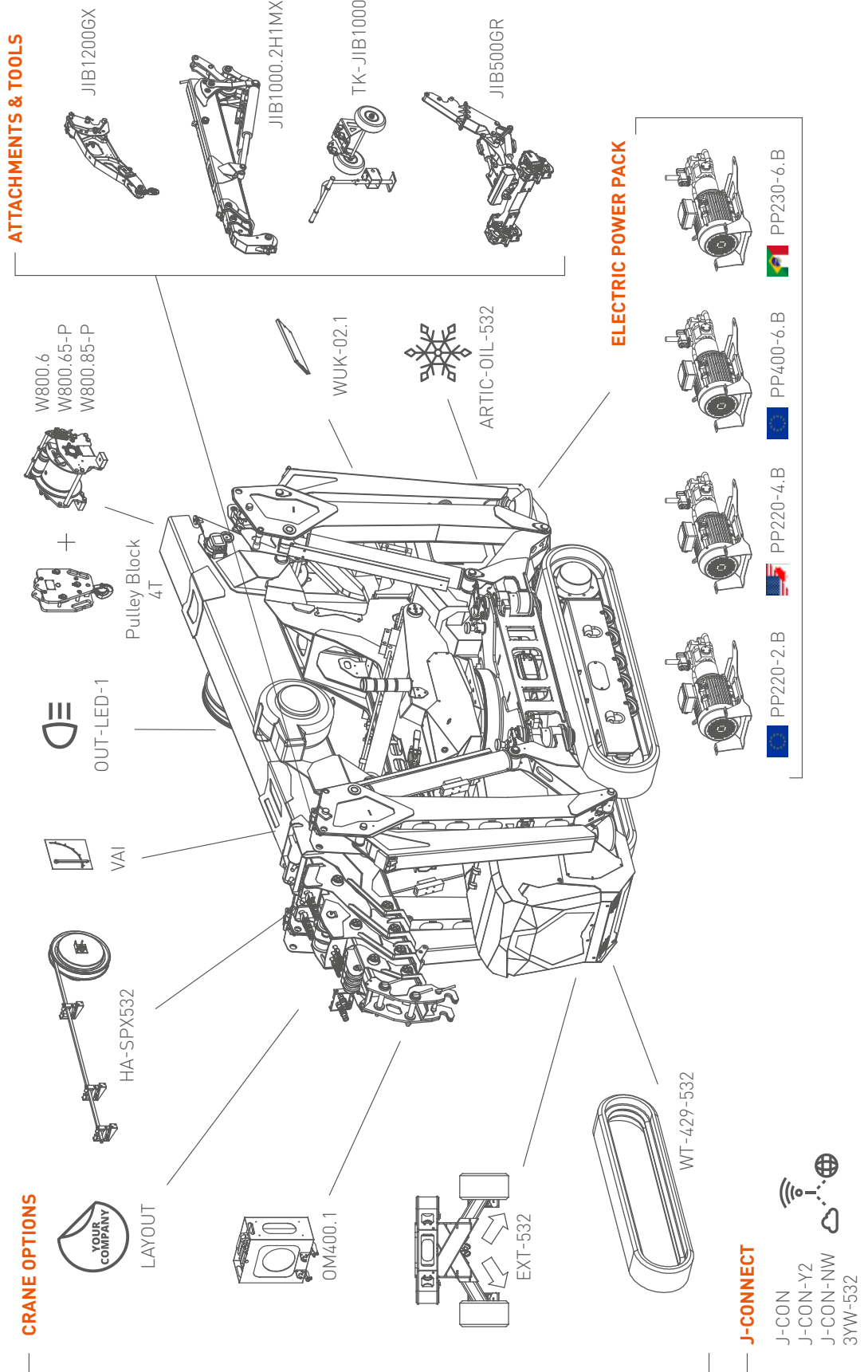

## ACCESSORIES SPX532CL

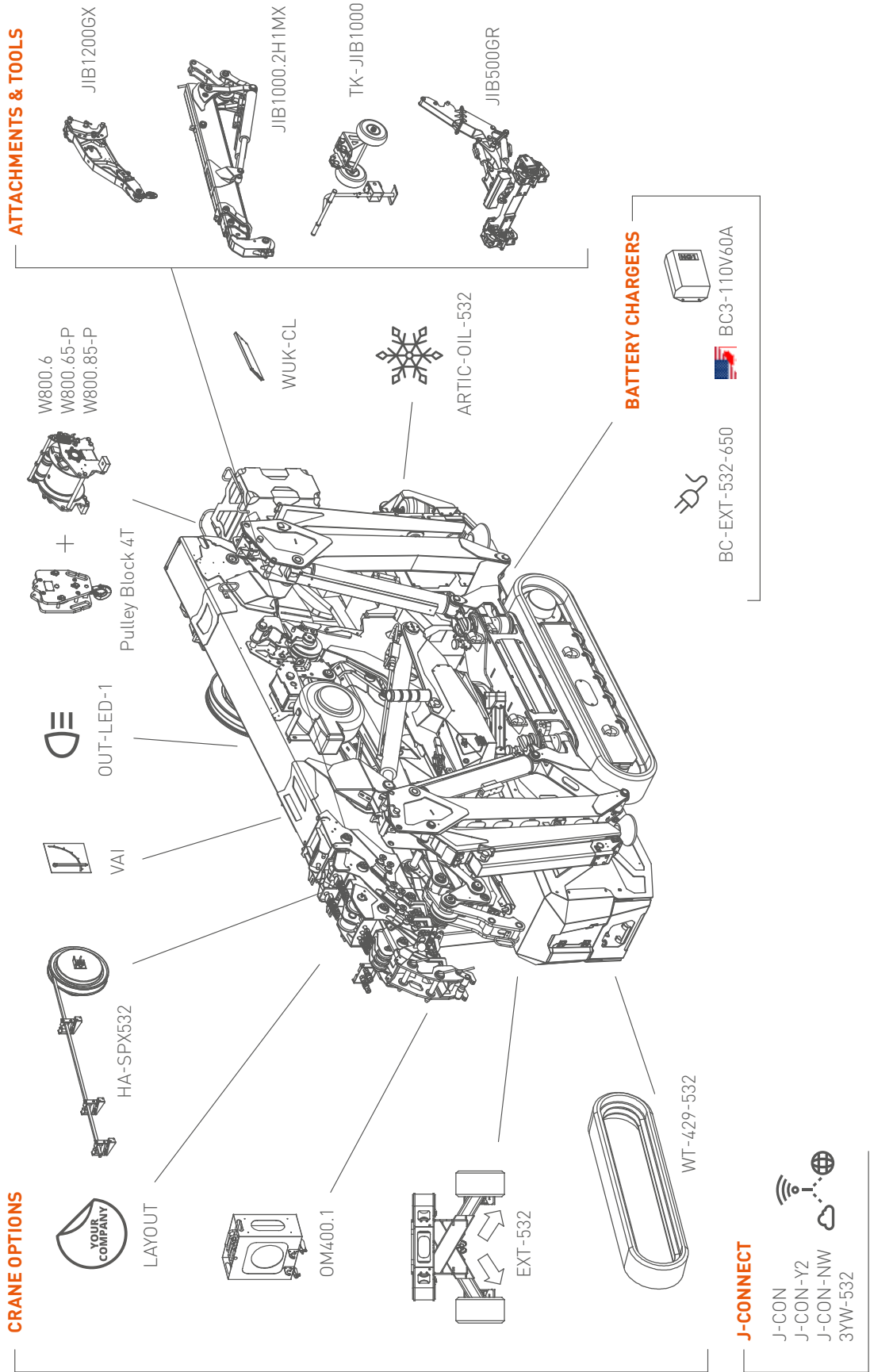

## ACCESSORIES FEATURES JIB1000.2H1MX

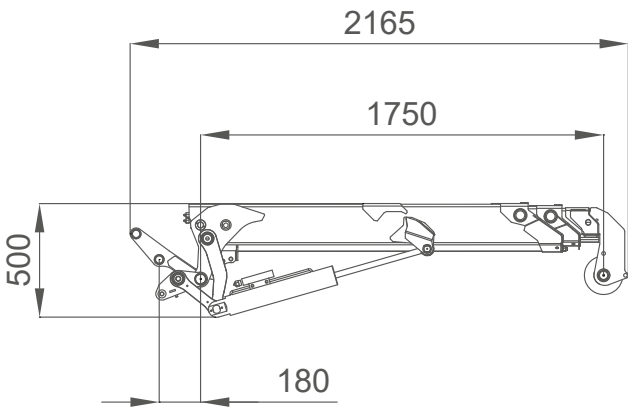
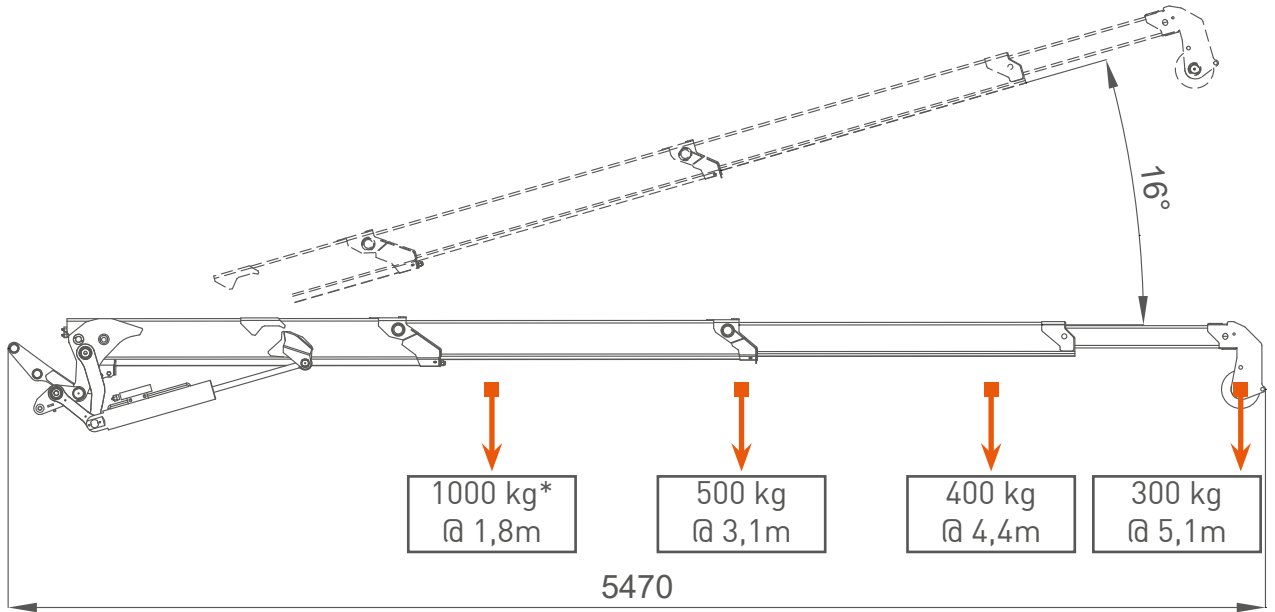

\*: Maximum capacity using hook, with winch this is limited to single fall winch capacity (800 kg).





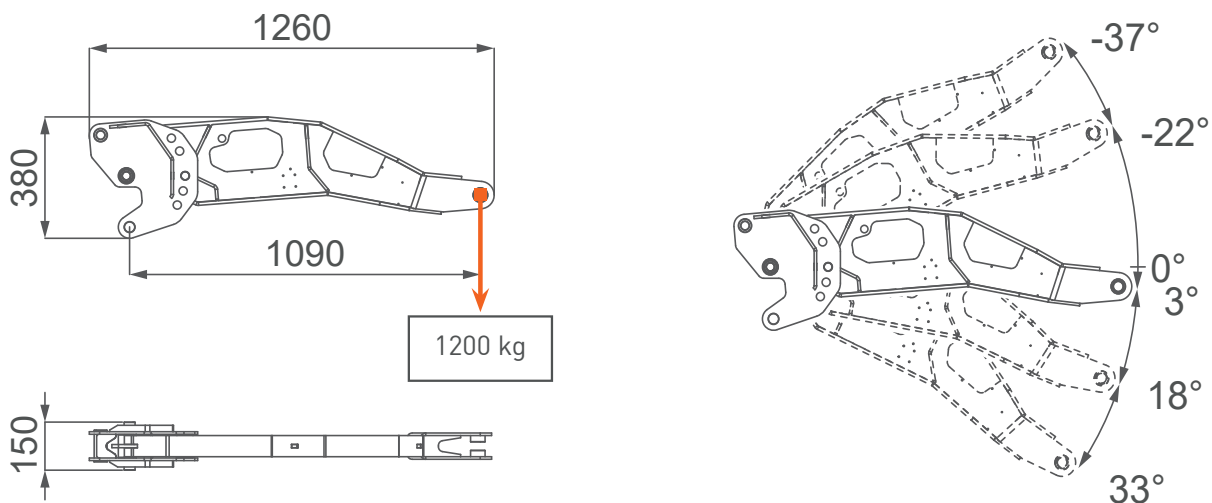



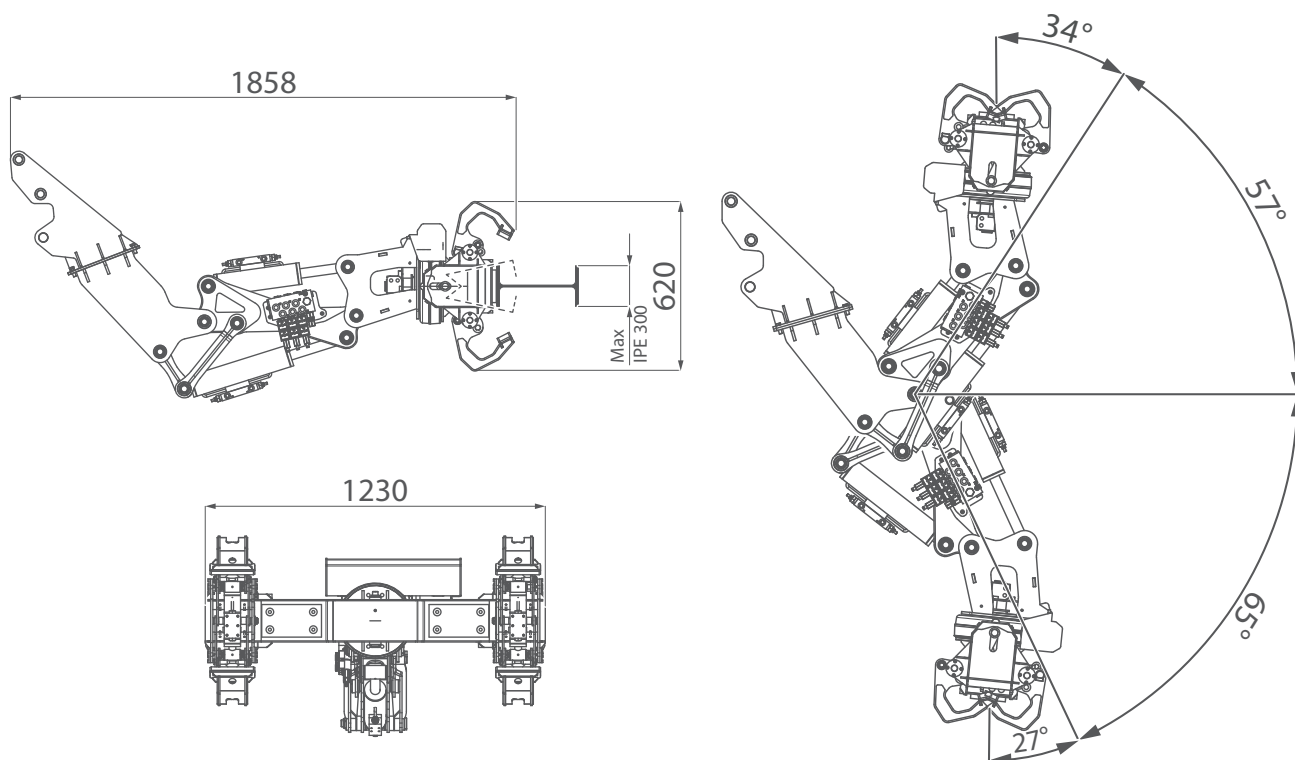













































## JIB1200GX



## JIB500GR



## SYMBOLS

	Weight		Engine		Boom Angle		Minipicker
	Counterweight		Diesel Fuel		Boom Length		Back Wheel Loading Point
	Crane		Petrol Fuel		Boom Radius		Front Wheel Loading Point
	Dimensions L x W x H		Tank		Jib on Board		Working Radius
	Stabilization Area		Power kW		Without Jib on Board		Stabilizing Bar
	Travel Speed		Battery		Jib Hook Radius		Standard EN
	Gradeability		Lithium Battery		Jib Length and Angle		Factory max. load
	Outrigger Load MAX		Powerpack AUX		Jib Length		Building site max. load
	Track Loading		Main Winch		Jib Radius		Maximum inclination of the machinery
	Outriggers Setup		Hookblock		Manipulator Length		Hydraulic oil
	Ext Tracks Width w		Slewing		Manipulator Radius		Winter Warm-up Kit
	Chart on Tracks		Slewing Locked		Number of vacuum pads		Horizontal Boom Angle
	Slope		Outriggers mats		Grabber		White Pads for Steel Tracks

### REMARKS REFERRING TO LOAD CHART

- The load charts are calculated according to EN 13000.
- For the calculation of the load charts at least a wind speed of 9m/s (33km/h) and regarding the load a sail area of 1m<sup>2</sup> per ton load and a wind resistance coefficient of 1.2 on the load have been taken into account. For lifting of loads with large sail areas and/or high wind resistance coefficients the maximum wind speed as stated in the load charts has to be reduced.
- Lifting capacities are given in kilograms.
- The weight of the hook blocks and hooks is part of the load and therefore it must be deducted from the lifting capacities.
- Working radii are measured from the slewing centre.
- The lifting capacities given for the telescopic boom apply if the folding jib is removed.
- Subject to modification of lifting capacities.

**YOUR  
JEKKO  
DEALER**

**EN** All specifications and features herein described can be changed without prior advice. All indicated data are indicative only and are not binding as crane performs differently depending on its use. **IT** Tutte le caratteristiche e le specifiche descritte possono essere soggette a variazioni senza preavviso. Tutti i dati riportati sono forniti a puro titolo informativo e non sono impegnativi dal momento che le prestazioni della macchina variano in funzione dell'utilizzo. **DE** Unangekündigte Änderungen sämtlicher Eigenschaften und Daten sind möglich. Alle Angaben sind Richtwerte und nicht verbindlich da die Leistungen der Vorrichtung von deren Einsatz abhängen. **ES** Todas las características y las especificaciones aquí indicadas pueden ser sujetas a variaciones sin aviso. Se dan todos los datos aquí indicados como simples informaciones. No se consideran como vinculantes, dado que las prestaciones del maquinario pueden variar. **FR** Toutes les caractéristiques et le spécifications descriptives peut être sujet à variation sans préavis. Tout les données rapportés sont fourni à titre informatif et ne sont pas engager au moment que la prestation de la machine change en fonction de l'emploi.



[www.jekko-cranes.com](http://www.jekko-cranes.com)

Visit [jekko-cranes.com](http://jekko-cranes.com) to keep in contact with us, discover all the latest news and find out technical details of all our products.

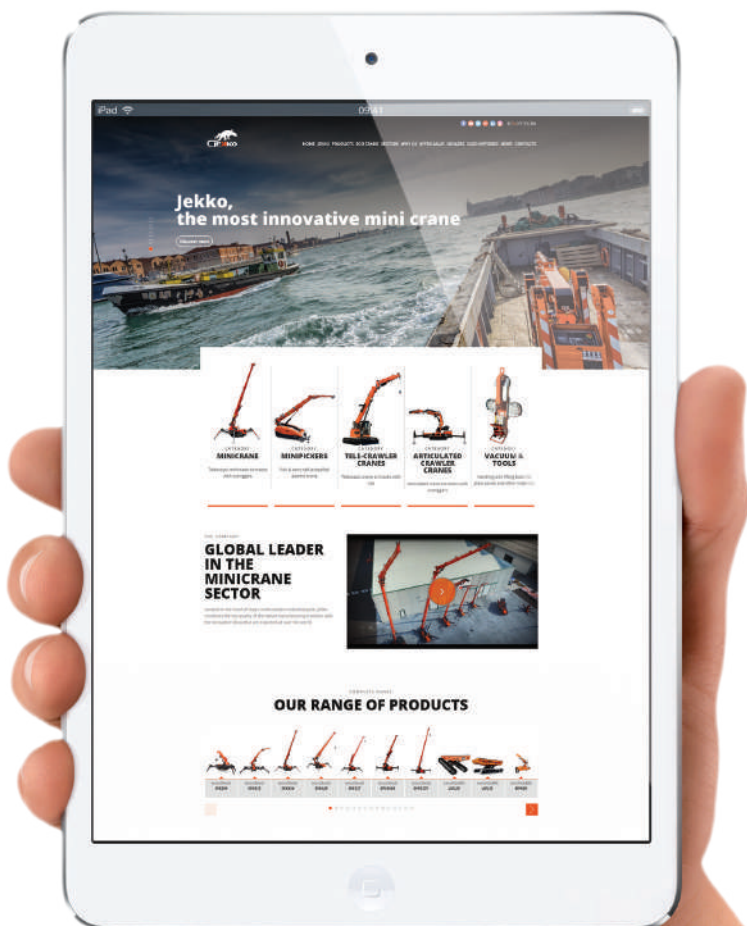



**Jekko s.r.l.**

Via Campardone, 1 - 31014 Colle Umberto (TV) - Italy  
info@jekko.it - www.jekko-cranes.com

28.02.2022 | Rev.10

SERIAL NUMBER: